

SERVICE MANUAL

OPERATING AND MAINTENANCE

INSTRUCTIONS & PARTS LIST

TRINCO TM

DRY-BLAST

TRINCO™ DRY BLAST MACHINERY

MODEL 48 / Bp2

**NEVER USE SILICA-BASED PRODUCTS
IN TRINCO™ BLAST SYSTEMS**
Ref. NIOSH Alert #92-102

TRINCO™

TRINITY TOOL COMPANY

34600 Commerce Road

Fraser, MI 48026

(586) 296-5900

Established 1951

TRINCO™
TRINITY TOOL COMPANY
Leader in Blast Cleaning Since 1951

34600 Commerce Road
Fraser, Michigan 48026
PH: (586) 296-5900
FAX: (586) 296-5836

! WARNING !

Do not proceed with use of
this equipment until you have read and
understood this manual.

**NEVER USE SILICA-BASED PRODUCTS
IN TRINCO™ BLAST SYSTEMS
Ref. NIOSH Alert #92-102**

These WARNINGS are included for the
health and safety of the operator and
those in the immediate vicinity.

The use of silica products will void any
warranty.

INTRODUCTION

This manual is provided as assistance for the proper installation, operation, and maintenance of your new TRINCO™ System.

Read this manual carefully before attempting installation or operation of this unit. Keep this manual handy, and refer to it often for maintenance, trouble shooting, parts ordering, and media information.

If you have any questions about the information contained in this manual, please contact **TRINITY TOOL COMPANY** at (586) 296-5900.

NEVER USE SILICA-BASED PRODUCTS
IN TRINCO™ BLAST SYSTEMS
Ref. NIOSH Alert #92-102

TRINITY TOOL COMPANY
34600 COMMERCE ROAD
FRASER, MI 48026
PHONE: (586) 296-5900
FAX: (586) 296-5836

THEORY OF OPERATION

Your Trinco Dry-blasting Cabinet is designed to work in conjunction with an air compressor and works in theory by the Venturi principle. During operation, the foot pedal is depressed which allows the foot valve to open up. Air from the compressor then passes through this valve and moves up through the air hose into the air jet assembly, located between the air hose and the hand-held gun. The abrasive is then propelled out of the nozzle by the air and blasted onto the desired part. The higher the air pressure, the faster the flow of abrasive. Lower pressure results in a slower flow.

The dust is drawn from the cabinet by the electrically-operated vacuum, or "dust collector" system, and deposited in the bottom canister of this accessory. Heavier dirt, dust or debris that may be blasted from the part falls to the floor of the cabinet, where it is filtered through a fine mesh screen. The re-usable abrasive falls through this screen to the bottom, or "hopper" section of the cabinet and is picked up by the siphon tube to begin the process again. This dust collection method is effective for intermittent blasting.

**NEVER USE SILICA-BASED PRODUCTS
IN TRINCOTM BLAST SYSTEMS**
Ref. NIOSH Alert #92-102

ASSEMBLY INSTRUCTIONS

TRINCO TRINITY TOOL CO (586)296-5900

STEP 1. AS YOU UNPACK YOUR BLAST CABINET PLEASE CHECK FOR THE FOLLOWING ITEMS:

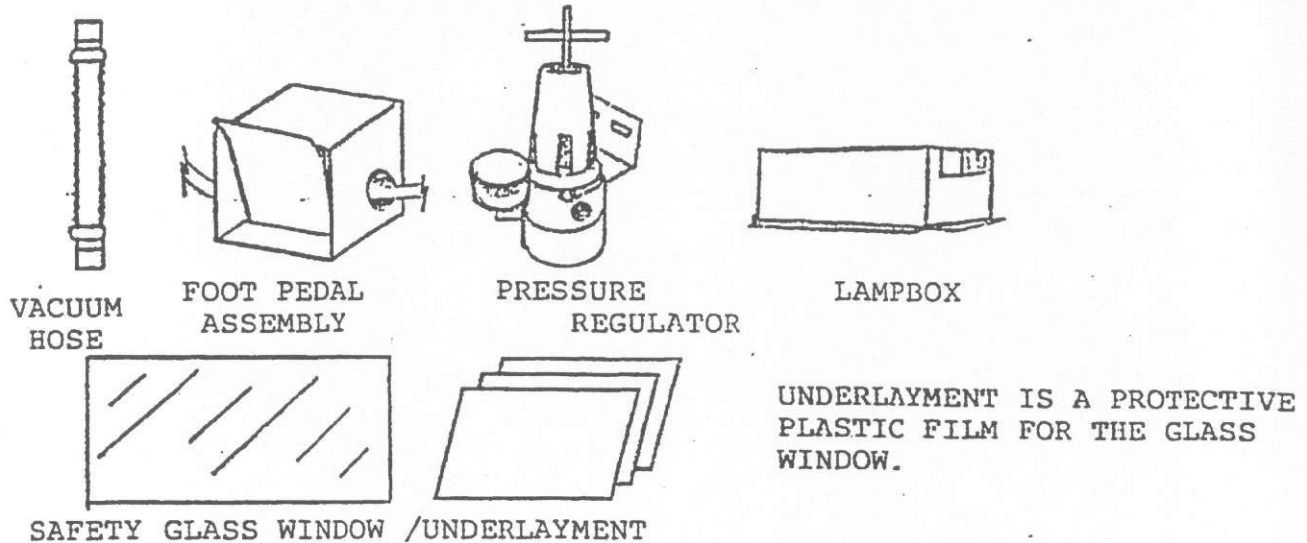

- STEP 2. POSITION BLAST CABINET IN THE DESIRED LOCATION.
- STEP 3. UNBOLT FROM SKID, REMOVE DUST COLLECTOR FROM BOX.
- STEP 4. ATTACH PRESSURE REGULATOR TO THE FRONT OF BLAST CABINET WITH BOLTS PROVIDED.
- STEP 5. PLACE FOOT PEDAL ASSEMBLY ON THE FLOOR IN FRONT OF THE BLAST CABINET.
- STEP 6. ATTACH YELLOW AIR HOSE TO THE BRASS NIPPLE ON THE PRESSURE REGULATOR.
- STEP 7. ATTACH GREEN AIR HOSE TO THE BRASS ELBOW ON THE BLAST CABINET HOPPER.
- STEP 8. REMOVE ALL PACKING MATERIAL FROM THE LAMP ASSEMBLY AND ATTACH TO TOP OF BLAST CABINET WITH THE THREE (3) BOLTS PROVIDED.
- STEP 9. REMOVE WINDOW FRAME AND THE CARDBOARD PANEL. PLACE PIECE OF UNDERLAYMENT AND PLACE OVER WINDOW OPENING. POSITION GLASS WINDOW OVER UNDERLAYMENT AND REPLACE WINDOW FRAME. CAUTION ! WHEN TIGHTENING WING NUTS USE CARE NOT TO OVER TIGHTEN AS GLASS MAY CRACK!!!
- STEP 10. PLACE DUST COLLECTOR BEHIND BLAST CABINET AND CONNECT VACUUM HOSE AS SHOWN.
- STEP 11. PLUG THE DUST COLLECTOR INTO THE LAMPBOX.
- STEP 12. PLUG LAMPBOX INTO 120 VOLT WALL OUTLET.

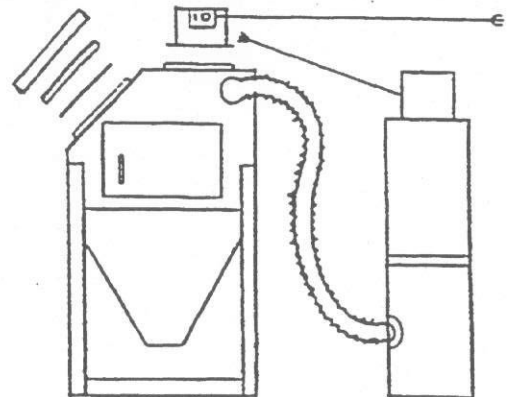

TRINCO™

(586)296-5900

TRINITY TOOL COMPANY

34600 COMMERCE RD.

P.O. BOX 98

FRASER, MI 48026-0098

ASSEMBLY CONT...

Remove the window frame and the cardboard panel. Cut a 12" X 24" piece of underlayment and place over window opening. Position glass window over underlayment and replace window frame. **CAUTION!** Do not over tighten wing nuts. Glass may crack!

Place lampbox on top of blast cabinet and attach with the three bolts provided.

Attach pressure regulator to the front of machine with the bolts provided.

Attach yellow air hose to the brass nipple on the pressure regulator.

Attach green air hose to the brass elbow on the machine hopper.

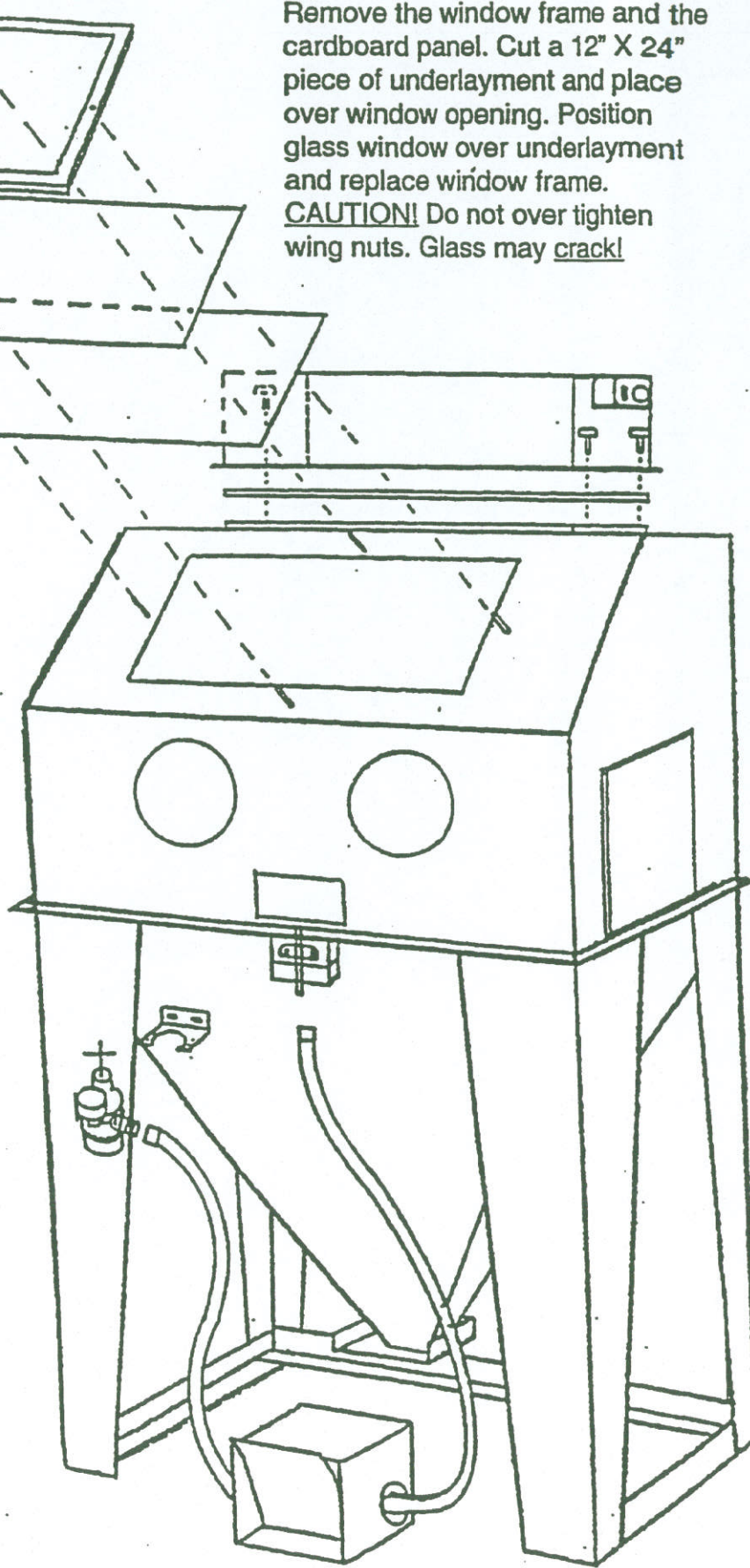

#2-192 UNDERLAYMENT, PRECUT, 12"X24" (10 PCS PER PACK)

AIR HOSE CONNECTION

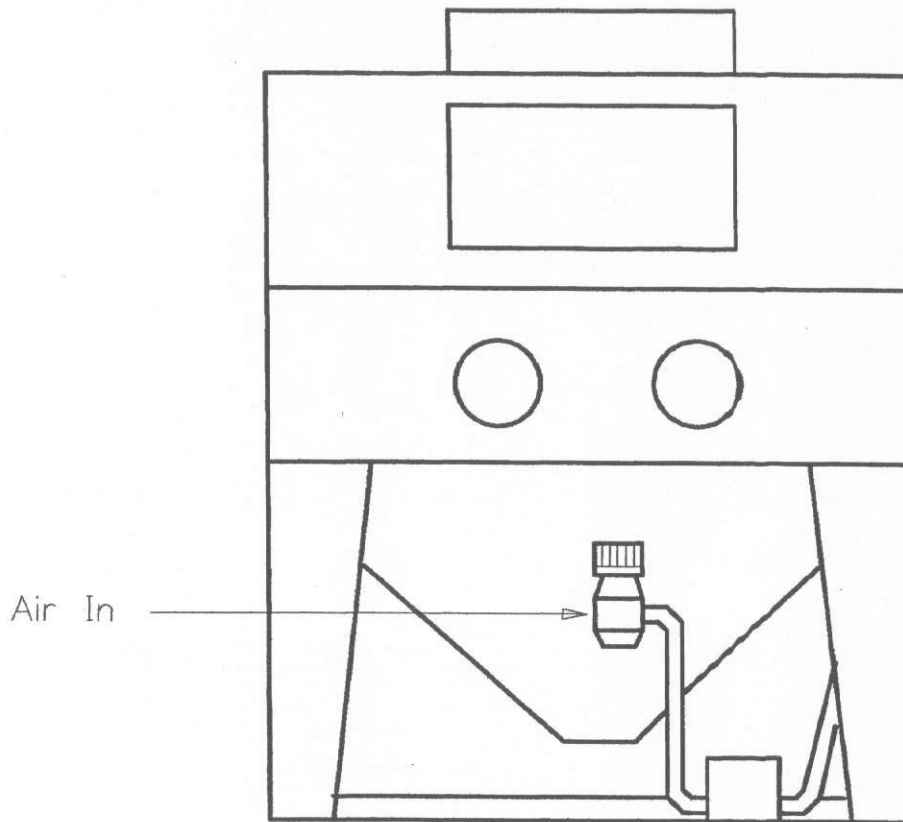

Blast cabinet must be supplied with compressed air delivered through a minimum of 1/2" I.D. air hose or piping. Distances greater than 25 feet require 3/4" I.D. Air inlet is 3/8" female thread. * Standard size supplied unless ordered otherwise. If unsure, remove air jet from back of gun and measure the I.D. Normal operating air pressure is 60-80 psi.

Air Requirements (SCFM)

	40 psi	60 psi	80 psi	100 psi
5/16" nozzle, 1/8" air jet	12	17	21	26
* 5/16" nozzle, 5/32" air jet	19	27	34	42
7/16" nozzle, 7/32" air jet	38	52	66	80

OPERATION

1. LOAD MACHINE WITH 25 TO 30 POUNDS OF ABRASIVE BLAST MEDIA. POUR MEDIA DIRECTLY INTO CABINET THROUGH THE STEEL MESH FLOOR.
2. SET PRESSURE REGULATOR TO DESIRED PRESSURE BEGINNING AT 60 PSI AND ADJUSTING UP OR DOWN UNTIL DESIRED RESULTS ARE ACHIEVED. MOST BLASTING IS DONE AT 80 PSI. (NOTE: THE HIGHER THE PRESSURE THE MORE QUICKLY THE MEDIA WILL BREAK DOWN.)
3. IF YOUR APPLICATION SEEMS TO BE TAKING AN INORDINANT AMOUNT OF TIME TO COMPLETE, EVEN AT HIGH PRESSURES, IT MAY BE DESIRABLE TO USE A MORE AGGRESSIVE BLAST MEDIA. CONSULT TRINITY TOOL CO. FOR AN ABRASIVE RECOMMENDATION.
4. AFTER PLUGGING DUST COLLECTOR INTO THE LAMPBOX AND THE LAMPBOX INTO A 120 VOLT WALL OUTLET, ACTIVATE THE SYSTEM BY PLACING THE SWITCH IN THE "ON" POSITION.
5. REACH INTO THE GLOVES, GRASP THE BLAST GUN AND DIRECT IT AT THE PART TO BE BLASTED. DIFFERENT ATTACK ANGLES ARE NECESSARY AND WILL DEPEND ON YOUR APPLICATION. EXPERIMENTATION WILL BE NEEDED BEFORE FINDING THE OPTIMUM ANGLE FOR YOUR PARTICULAR JOB. GENERALLY A 45° ANGLE PROVIDES EFFICIENT RESULTS.
6. THE DISTANCE BETWEEN THE WORKPIECE AND THE NOZZLE VARIES ACCORDING TO YOUR APPLICATION. GENERALLY A DISTANCE OF 2" TO 4" IS BEST.
7. TO BEGIN BLASTING, PLACE YOUR FOOT INSIDE FOOT PEDAL AND DEPRESS THE STEEL FLAP OVER THE VALVE. ABRASIVE FLOW WILL BEGIN ALMOST IMMEDIATELY, BE READY BY HAVING THE GUN DIRECTED AT THE PART. NEVER LOOK INTO THE NOZZLE AND BLAST, AS THIS WILL FOG THE WINDOW.
8. PASS NOZZLE OVER THE AREA TO BE CLEANED IN A WIDE SWEEPING MOTION. DO NOT TREAT ONE SPOT FOR AN EXTENDED PERIOD OF TIME, AS THIS CAN RESULT IN AN UNEVEN FINISH.
9. ONCE DESIRED RESULT IS ACHIEVED, REMOVE YOUR FOOT FROM THE PEDAL AND THE ABRASIVE FLOW WILL STOP IMMEDIATELY. BE SURE AND REMOVE YOUR FOOT COMPLETELY FROM PEDAL BEFORE OPENING ANY DOORS!
10. BEFORE REMOVING YOUR WORKPIECE ALLOW ENOUGH TIME FOR THE BLAST CHAMBER TO CLEAR. WHEN BLASTING IS FINISHED, TURN SWITCH OFF.

CHANGING ABRASIVE MEDIA

1. REMOVE SIPHON HOSE FROM GUN STEM AND CLEAN INTERIOR OF BLAST CABINET TO DISLodge LOOSE MEDIA.
2. PLACE SUITABLE CONTAINER BENEATH THE TRAP DOOR AT THE BOTTOM OF HOPPER AND OPEN THE TRAP DOOR.
3. ONCE MEDIA HAS DRAINED, ALLOW TRAP DOOR TO CLOSE AND DISPOSE OF (OR STORE) OLD MEDIA IN SUITABLE CONTAINER.
4. ADD FRESH MEDIA.

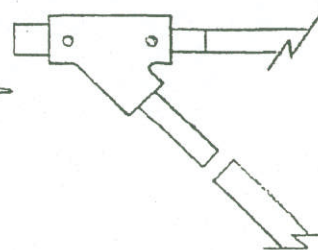

TRINCO BP FILTER BAG REPLACEMENT

TRINCO TRINITY TOOL CO. PH #586-296-5900

1. Un-plug dust collector power cord from lampbox.
2. Remove vacuum hose from bottom drum.
3. Un-latch BP drum clamp. Remove top drum from bottom drum and place on floor with open end facing up.
4. Un-clamp filter bag from top drum.
5. Replace with new filter bag -every 4 months is recommended. Install new bag with smooth side and washer towards motor as shown. Fold approx 2" of bag over outside of top drum and clamp securely.
6. Empty dust out of bottom drum -do not let dust level accumulate higher than indicated on drum.
7. Place top drum back over bottom drum. Clamp drums back together.
8. Plug power cord into lampbox receptacle.
9. Plug vacuum hose into bottom drum.

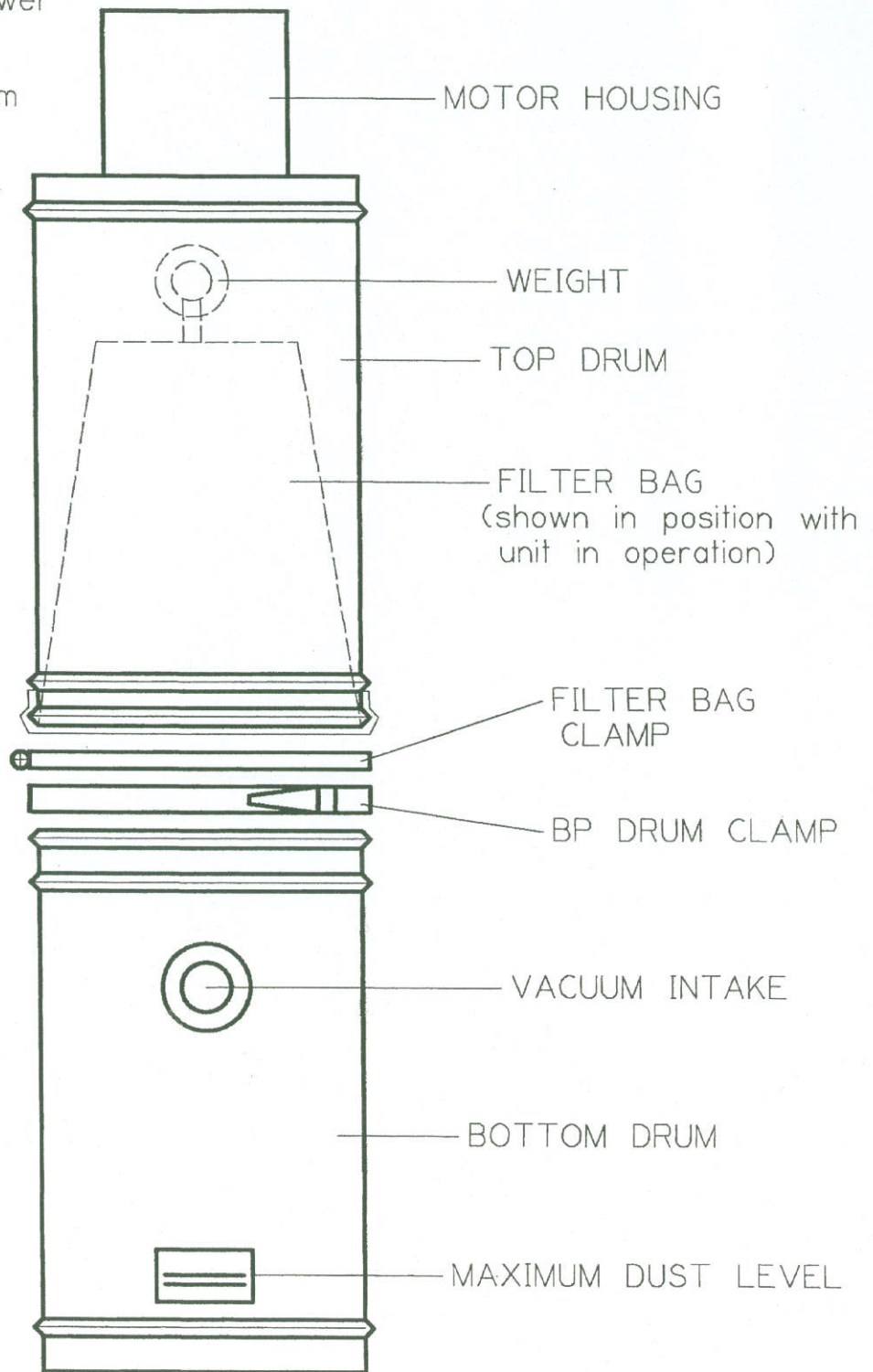

TROUBLE SHOOTING/ ROUTINE MAINTENANCE

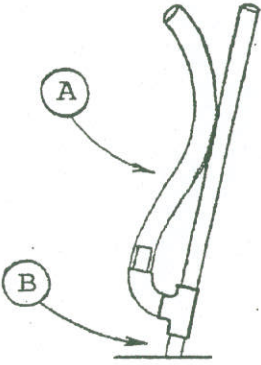
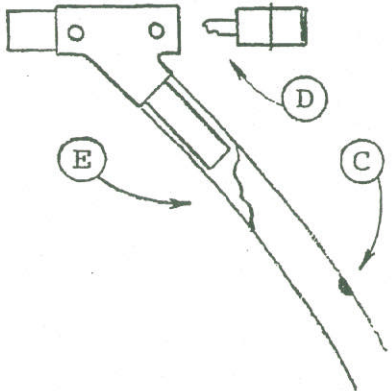
PROBLEM	CAUSE	SOLUTION
<p>PULSATING MEDIA FLOW</p>	<p>DAMP OR WET MEDIA MEDIA PACKING IN HOPPER FREE AIR INTAKE BLOCKED OR MISSING. (A)</p>	<p>REPLACE WITH DRY MEDIA REDUCE QUANTITY TO 25 POUNDS. REMOVE BLOCKAGE OR REPLACE AS NECESSARY.</p>
<p>AIR FLOW WITHOUT MEDIA</p> 	<p>BLOCKAGE IN GUN SYSTEM (E)</p> <p>LACK OF MEDIA DAMP OR WET MEDIA MEDIA INTAKE BLOCKED. (B)</p> <p>HOLE OR THIN SPOT IN SIPHON HOSE (C)</p>	<p>BACK PRESSURE SYSTEM BY PLACING GLOVED HAND OVER NOZZLE AND DEPRESSING FOOT PEDAL. IF THIS DOES NOT CLEAR BLOCKAGE, DISASSEMBLE AND CLEAR MANUALLY. FILL TO 25 POUNDS REPLACE WITH DRY MEDIA. CHECK THE BASE OF THE SIPHON TUBE ASSEMBLY AND BE SURE THAT IT IS NOT SEALED AGAINST THE TRAP DOOR GASKET. REPLACE SIPHON HOSE</p>
<p>SLOW PRODUCTION</p> 	<p>INCORRECT MEDIA USED BROKEN DOWN MEDIA WORN NOZZLE AND/OR AIR JET. (D)</p> <p>LOW OPERATING PRESSURE LACK OF AIR PRESSURE</p>	<p>CONSULT TRINCO FOR AN ABRASIVE RECOMMENDATION. REPLACE WITH FRESH MEDIA REPLACE AIR JET IF MEDIA HAS WORN INTO THE I.D. REPLACE NOZZLE IF WORN UNEVENLY. NOTE: AIR JET SHOULD BE ROTATED 1/4 OF A TURN EVERY 8 HOURS OF BLASTING INCREASE PRESSURE MOST SAND BLASTING REQUIRES AN AIR SUPPLY WHICH WILL ALLOW FOR A CONSTANT PRESSURE OF 80 PSI.</p>

TRINCO TRINITY TOOL
34600 COMMERCE RD FRASER MI 48026

PHONE: 586-296-5900
FAX: 586-296-5836

MEDIA DATA

TRIN-MIXES: Trinco's exclusive combination of glass bead and aluminum oxide delivers fast and efficient cutting action while maintaining close tolerance and a fine satin finish. With three grades to choose from, one will be the solution to your cleaning/finishing application.

TRIN-MIX # 4: The finest of the Trin-Mixes, Trin-Mix # 4 is ideal for removing light to medium contamination from tools, tooling, molds and dies. It is considered a general purpose media which can be used in a wide range of applications from texturing plastic injection molds to providing appealing finishes on exposed stainless steel and aluminum surfaces. Dimensional change of less than .001 inch can be expected.

TRIN-MIX # 2: Somewhat more aggressive than Trin-Mix # 4, Trin-Mix # 2 promotes faster cleaning and a slightly rough finish. Ideal for heavier contamination where a dimensional change of minus .001 inch is acceptable.

RAD-MIX: This is the most aggressive of the Trin-Mixes. Although developed for the radiator rebuilding industry, it is ideal for removing tough contamination from surfaces with a minus .001 inch tolerance or better.

TRIN-BEADS (Glass Bead): A very popular media used primarily for dimensionally sensitive applications where tolerance and finish are your main concern. It is used widely by automotive rebuilders, die and mold makers, the plating and aircraft-aerospace industries. Trin-Beads are perfect for removing medium to light contamination without causing dimensional change, over-stressing, imbedding or pitting. Mesh sizes range from extra coarse # 3 (20-30 mesh) to extra fine # 13 (170-325 mesh). **Following are descriptions of typical applications:**

COARSE - BT # 3 & 4: Good for cleaning heavier contamination and peening for stress.

MEDIUM COARSE - BT # 5, # 6, & # 7: Good for engine rebuilding, mold texturing, and peening of softer metals.

MEDIUM - BT # 8, # 9, # 10: Good for plating, anodizing preparation, and most general applications.

FINE - BT # 12 & # 13: Good for cleaning light contamination and wherever a fine surface finish is desired.

TRIN-BLAST (Aluminum Oxide): A highly aggressive abrasive ideal for applications where tough contamination is encountered and stock removal of .001 to .002 inches is acceptable. The resulting finish is ideal for painting, plating, coating or wherever a matte finish is desired. Grit sizes range from # 12 (Coarse) to # 240 (Fine).

SILICON CARBIDE: This extremely aggressive abrasive is used in many of the same applications as aluminum oxide, where faster cleaning and/or deeper etching is required.

WALNUT SHELLS: This soft aggregate is used in blasting processes for removal of foreign matter or coatings from surfaces without etching, scratching, or marring the cleaning area.

i.e. Cleaning delicate molds, armatures and/or electric motors prior to rewinding.

COB GRIT: Known as soft grit blasting, this natural cellulose grit is derived from corn cobs; used for removing light foreign matter such as carbon, oil and dirt without affecting surface.

STEEL SHOT: A solid round particle causing a peening action and producing a dimpled surface. Its heavy weight gives greater impact and hammering action for peening and cleaning heavy forgings and removing heat treat scale.

STEEL GRIT: An angular media, and like thousands of tiny chisels and cutting tools, does a fast cleaning job. Produces an ideal surface for adherence of new coatings. Often shot and grit can be mixed to achieve different finishes.

PLASTIC: This relatively new, dust-free media is a special formulation of plastic material that has high tensile, compressive and flexural strength, combined with comparatively low hardness. Used for deflashing plastic parts and cleaning molds, dies, electronic connections, and circuit boards. It can effectively deburr machined-iron castings and non-ferrous screw machine parts.

**NEVER USE SILICA-BASED PRODUCTS
IN TRINCO™ BLAST SYSTEMS
Ref. NIOSH Alert #92-102**

WHY SILICA SAND IS A POOR CHOICE FOR USE IN DRY-BLAST CABINETS!

1. **Potentially Hazardous** - Silicon dioxide dust found in silica sand has been linked to a respiratory disease known as silicosis.
2. **Short Life Span** - Breaks down to dust very rapidly, requiring constant refills.
3. **Extremely Dusty** - High levels of dust generated in cabinet impairs operator's vision, which reduces production.
4. **Slow Results** - Because of its short life span, it is often used in an inefficient, powdery and dusty condition, with very slow results.
5. **Reduced Filter Life** - Excessive dust levels in cabinet saturate and choke off filter bags, greatly reducing filter performance and life span.
6. **Inconsistent Results** - You may find an inconsistent finish on parts due to the inadequate particle screening, inconsistent grain size, and foreign matter found in silica sand.
7. **Hose Blockage** - Foreign matter and/or packed silica dust in silica sand can cause blockage or clogging in cabinet's hose, siphon tube, or blast gun.

For superior abrasive alternatives refer to Trinco "Media Data" flyer or consult Trinity Tool Co. for recommendations.

NEVER USE SILICA-BASED PRODUCTS
IN TRINCO™ BLAST SYSTEMS
Ref. NIOSH Alert #92-102

Trinity Tool Company
34600 Commerce Road
Fraser, MI 48026
Telephone [586] 296-5900
Fax [586] 296-5936

TRINCO MODEL 48/BP

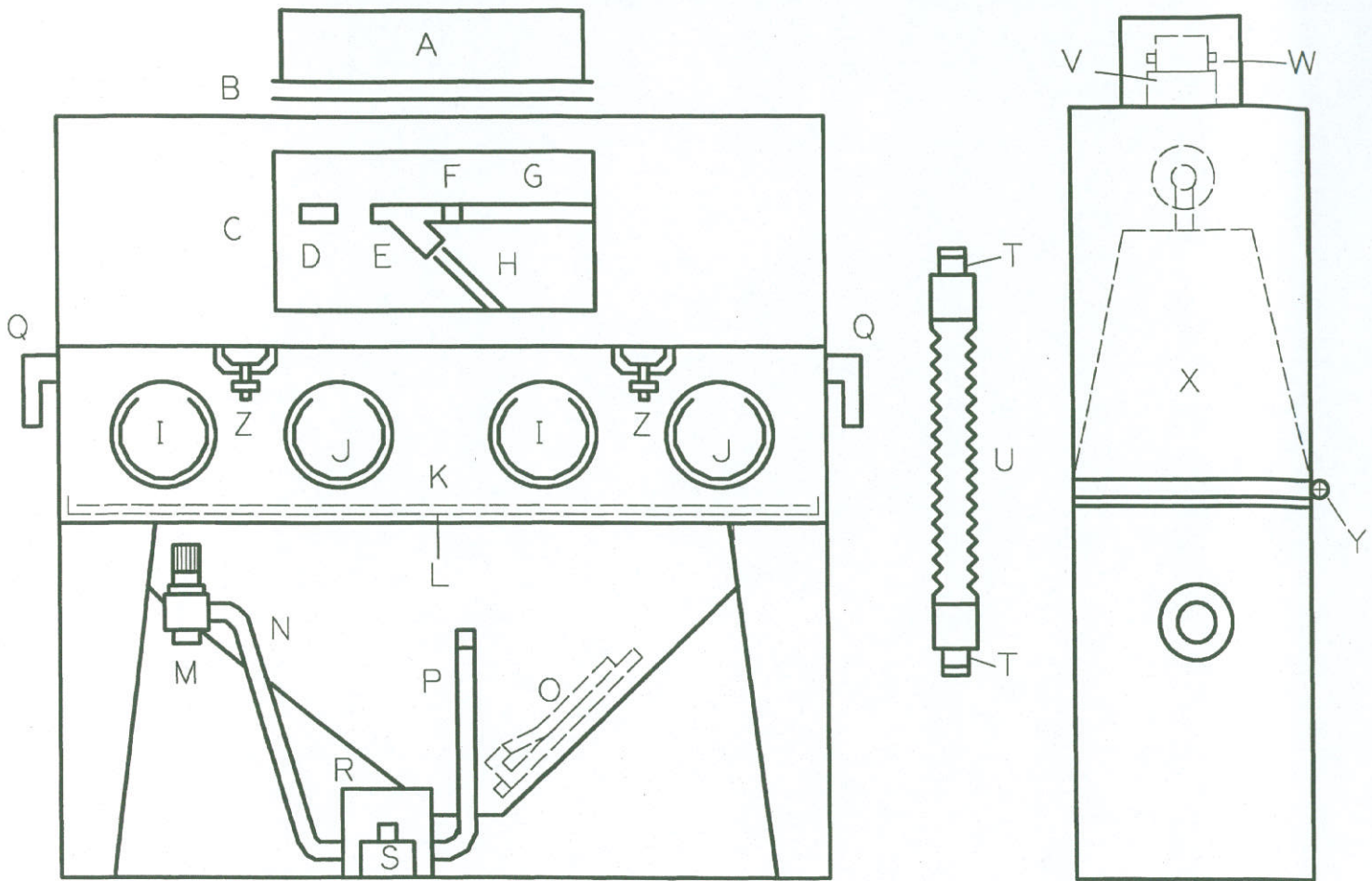

TRINCO Trinity Tool Co. (586)296-5900





Part #	Description	Part #	Description
A 4-0053	Lampbox Assm 115V	R 2-0041	Foot Pedal With Valve
B 2-0082	Lampshield 12"x25"	S 2-0121	Foot Valve Only
C 2-0110	Window, Glass, 12"x24"	T 4-0133	Rubber Seal Ring
D 2-0071	Nozzle, 5/16" ID	U 2-0093	Vacuum Hose
E 2-0061	Gun Incl. Airjet Assm.	V 2-0083	Motor and Turbine Assm.
F 2-0052	Airjet Assm. 25 CFM	W 2-0008	Motor Brushes
G 2-0001	Airhose, Black	X 2-0030	Filter Bag, Weighted
H 2-0095	Siphon Hose 5/8" ID	Y 4-0026	Filter Bag Clamp
I 2-0047	Gloves, Rubber 6"x24"	Z 2-0018	Door Latch, Small
J 4-0034	Glove Ring Liner 6"		2-0192 Underlayment, 12"x24"
K 2-0023	Expandex Floor 48"x24"		2-0044 Gasketing, 1"x1/2"
L 2-0013	Carbon Screen 48"x24"		2-0131 Gasketing, 1-1/2"x1/2"
M 2-0086	Pressure Regulator		2-0111 Gasketing, 1"x3/8"
N 2-0114	Air Hose, Yellow		2-0043 Gasketing, 1/2"x1/2"
O 2-0090	Siphon Tube Assm.		2-0101 Optional Moisture Filter
P 2-0112	Air Hose, Green		2-0055 Optional Blow-Off Gun
Q 2-0127	Side Door Handle		171800 Turntable, 18" dia.

Model 48/BP2
Suggested Spare Parts

TRINCO™

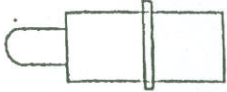
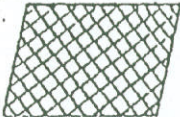
TRINITY TOOL COMPANY

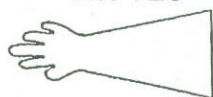
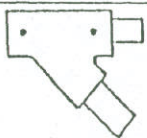
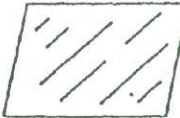
(586)296-5900

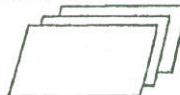
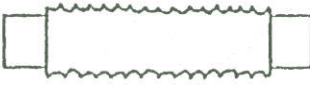
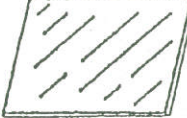
<p>AIR JET ASSEMBLY</p> 	<p>CARBIDE JET IN BRASS HOLDER. POOR ABRASIVE FLOW WHEN WORN. INSPECT AND ROTATE FREQUENTLY.</p>	<p>2-52 2 Suggested \$10.00 each</p>
<p>CARBON SCREEN</p> 	<p>FINE MESH SCREEN FLOOR PREVENTS DEBRIS FROM BLOCKING GUN SYSTEM.</p>	<p>2-13 1 Suggested \$17.00 each</p>
<p>FILTER BAG</p> 	<p>CLAMPED TO TOP DRUM OF DUST COLLECTOR. MUST BE REPLACED OFTEN TO PREVENT DUST AND MOTOR DAMAGE.</p>	<p>2-30 3 Suggested \$14.00 each</p>
<p>GASKETING A. 4ft/1/2"x1/2" \$1.15/ft. B. 24ft/1"x1/2" \$1.25/ft. C. 6ft/1"x3/8" \$1.25/ft. D. 2ft/1/2"x1/2" \$1.40/ft.</p>	<p>GASKETING USED TO SEAL ALL DOORS, WINDOWS AND LAMP OPENINGS. REPLACE WHEN WORN.</p>	<p>A. 2-43 B. 2-44 C. 2-111 D. 2-131</p>
<p>GLOVES</p> 	<p>RUBBER GLOVES PROTECT HANDS DURING BLASTING. REPLACE WHEN WORN.</p>	<p>2-47 2 Suggested \$19.00 each</p>
<p>GUN, INCLUDING AIR JET ASSEMBLY</p> 	<p>HANDLE ASSEMBLY WHERE AIR AND ABRASIVE MIX. ROTATE AIR JET TO INCREASE LIFE. INSPECT OFTEN FOR WEAR.</p>	<p>2-61 1 Suggested \$36.00 each</p>
<p>LAMP SHIELD</p> 	<p>PROTECTS THE LAMPS. REPLACE OFTEN FOR GOOD ILLUMINATION IN CABINET.</p>	<p>2-82 3 Suggested \$9.00 each</p>
<p>NOZZLE</p> 	<p>CARBIDE NOZZLE DIRECTS ABRASIVE SPRAY FROM GUN. INSPECT AND ROTATE FREQUENTLY.</p>	<p>2-71 3 Suggested \$21.00 each</p>
<p>SIPHON HOSE</p> 	<p>FLEXIBLE HOSE CARRIES ABRASIVE TO GUN. INSPECT OFTEN FOR HOLES OR SOFT AREAS.</p>	<p>2-95 8ft Suggested \$1.10/ ft.</p>
<p>UNDERLAYMENT</p> 	<p>PRE-CUT PLASTIC LINERS PROTECT GLASS WINDOW. 10 SHEETS PER PACKAGE. REPLACE OFTEN.</p>	<p>2-192 5 Suggested \$4.50/ pkg.</p>
<p>VACUUM HOSE</p> 	<p>FLEXIBLE HOSE CARRIES DUST FROM CABINET TO COLLECTOR. REPLACE AS NEEDED.</p>	<p>2-93 1 Suggested \$8.50 each</p>
<p>SAFETY GLASS WINDOW</p> 	<p>LAMINATED SAFETY GLASS VIEWING WINDOW. SHOULD BE PROTECTED WITH UNDERLAYMENT.</p>	<p>2-110 1 Suggested \$21.50 each</p>

GASKETING CHART



TRINITY TOOL COMPANY
34600 COMMERCE ROAD
FRASER MI 48026

PH (586) 296-5900
FAX (586) 296-5836

	TOP LID	LAMP BOX	SIDE DOOR (s)	HINGE	WINDOW	
MODEL 20/88ST	4ft	3ft			2ft	6ft
	1" x 1/2"	1" x 1/2"			1/2" x 1/2"	1" x 3/8"
MODEL 20	4ft	3ft			2ft	6ft
	1" x 1/2"	1" x 1/2"			1/2" x 1/2"	1" x 3/8"
MODEL 24	5ft	3ft			2ft	6ft
	1" x 1/2"	1" x 1/2"			1/2" x 1/2"	1" x 3/8"
MODEL 30	5ft	3ft			3ft	6ft
	1" x 1/2"	1" x 1/2"			1/2" x 1/2"	1" x 3/8"
MODEL 36	6ft	5ft	2ft	5ft	3ft	6ft
	1" x 1/2"	1" x 1/2"	1 1/2" x 1/2"	1" x 1/2"	1/2" x 1/2"	1" x 3/8"
MODEL 36x30	6ft	5ft	2ft	6ft/per door	3ft	6ft
	1" x 1/2"	1" x 1/2"	1 1/2" x 1/2"	1" x 1/2"	1/2" x 1/2"	1" x 3/8"
MODEL 48	7ft	5ft	2ft	6ft/per door	4ft	6ft
	1" x 1/2"	1" x 1/2"	1 1/2" x 1/2"	1" x 1/2"	1/2" x 1/2"	1" x 3/8"
MODEL 42x24	12ft	5ft	2ft	4ft		6ft
	1" x 1/2"	1" x 1/2"	1 1/2" x 1/2"	1" x 1/2"		1" x 3/8"
MODEL 48x24	13ft	5ft	2ft	4ft		6ft
	1" x 1/2"	1" x 1/2"	1 1/2" x 1/2"	1" x 1/2"		1" x 3/8"
MODEL 40x40	11ft	5ft	2ft	9ft	4ft	6ft
	1 1/2" x 1/2"	1" x 1/2"	1 1/2" x 1/2"	1 1/2" x 1/2"	1/2" x 1/2"	1" x 3/8"
MODEL 48x36		5ft	2ft	11ft/per door		6ft
		1" x 1/2"	1 1/2" x 1/2"	1 1/2" x 1"		1" x 3/8"
MODEL 48x48	13ft	5ft	2ft	10ft	4ft	6ft
	1 1/2" x 1/2"	1" x 1/2"	1 1/2" x 1/2"	1 1/2" x 1"	1/2" x 1/2"	1" x 3/8"
MODEL 60x24	15ft	5ft	2ft	6ft		6ft/per window
	1" x 1/2"	1" x 1/2"	1 1/2" x 1/2"	1" x 1/2"		1" x 3/8"
MODEL 60x48	14ft	5ft/per lamp	2ft/per lamp	10ft/per door	5ft	6ft/per window
	1 1/2" x 1/2"	1" x 1/2"	1 1/2" x 1/2"	1 1/2" x 1"	1/2" x 1/2"	1" x 3/8"
BANDSAW	6ft	3ft				3ft
	1 1/2" x 1/2"	1" x 1/2"				1/2" x 1/2"
TUMBLE BLASTER				12ft		
				1" x 1/2"		

TRINCO PART NUMBERS:

2-43 1/2" x 1/2"
2-44 1" x 1/2"
2-45 1 1/2" x 1"

2-111 1" x 3/8"
2-131 1 1/2" x 1/2"
4-039 R/C Side Dr
4-030 Trap Door

NEVER USE SILICA-BASED PRODUCTS
IN TRINCO™ BLAST SYSTEMS
Ref. NIOSH Alert #92-102

TRINCO™ DRY BLAST

Parts List and Prices

	Old Part No.	New Part No.
ACCESSORIES		
Abrasive Separator, Retrofit Kit, 300 CFM (Glass Beads)		1-70300
Abrasive Separator, Retrofit Kit, 450 CFM (Alum Oxide)		1-70450
Abrasive Separator, Retrofit Kit, 600 CFM		1-70600
Automatic Power Basket, 8" x 8"		1-70088
Automatic Power Basket, 8" x 12"		1-70812
Automatic Power Basket, 12" x 12"		1-71212
Basket, Plastisol 8" x 8"	PB-88	2-00002
Basket, Plastisol 8" x 12"	PB-812	2-00003
Basket, Plastisol 12" x 12"	PB-1212	2-00004
Blow-Off Gun	B-6	2-00005
Dust Collector, Bench Model		1-70701
Dust Collector, BP (Specify 2 1/2" or 4" Hose Size)		1-70700
Dust Collector, Enclosed Deluxe		1-70725
Dust Collector, Pull Through, 400 CFM		1-70740
Dust Collector, Pull Through, 800 CFM		1-70730
Turntable, Manual — 18" Dia. 300 Lb Capacity		1-71800
Turntable, Manual — 26" Dia 500 Lb. Capacity		1-72000
Turntable, Manual — 36" Dia 2,000 Lb. Capacity*		1-72001
GUNS, NOZZLES and AIR JETS		
Air Jet Assembly, G-100 Gun, 12 CFM	GA-66	2-00050
Air Jet Assembly, G-100 Gun, 6 CFM		2-00130
Air Jet Assembly, G-34-L Gun, 12 CFM	GA-34-L	2-00051
Air Jet Assembly, G-34-L Gun, 25 CFM	GA-34-L	2-00052
Air Jet Assembly, G-34-L Gun, 45 CFM		2-00132
Air Jet Assembly, G-77-L Gun, 25 CFM	GA-77-L	2-00053
Air Jet Assembly, G-77-L Gun, 45 CFM	GA-77-L	2-00054
Gun, Incl. Air Jet Less Nozzle, 9/16" I.D. 12 CFM	G-100	2-00060
Gun, Incl. Air Jet Less Nozzle, 9/16" I.D. 6 CFM		2-00133
Gun, Incl. Air Jet Less Nozzle, 3/4" I.D. 25 CFM	G-34-L	2-00061
Gun, Incl. Air Jet Less Nozzle, 3/4" I.D. 12 CFM		2-00134
Gun, Incl. Air Jet Less Nozzle, 3/4" I.D. 45 CFM		2-00135
Nozzle, Carbide, 9/16" O.D. (For G-100 Gun, 6 or 12 CFM)	916	2-00070
Nozzle, Carbide, 3/4" O.D. (For G-34-L Gun, 12 or 25 CFM)	340-S	2-00071
Nozzle, Carbide, 3/4" O.D. (For 45 CFM Guns)	GN-77	2-00072
Nozzle, Carbide, 1/16" I.D. For Pencil Gun		5-00004
Nozzle, Carbide, 1/8" I.D. For Pencil Gun		5-00013
Pencil Gun, Assembly, 1/16" I.D. Nozzle		5-00008
Pencil Gun, Retrofit Kit, 1/16" I.D. Nozzle		5-00009
Pencil Gun, Assembly 1/8" I.D. Nozzle		5-00014
Pencil Gun, Retrofit Kit, 1/8" I.D. Nozzle		5-00012
STANDARD PARTS		
Air Hose, Coupled and End Fittings, Black	HA	2-00001
Air Hose, Coupled and End Fittings, Green		2-00112
Air Hose, Coupled and End Fittings, Orange		2-00113
Air Hose, Coupled and End Fittings, Yellow		2-00114
Brushes (Elec. Motor) 115548-BP		2-00006
Brushes (Elec. Motor) 115898-BP-2		2-00008

*Cabinet Floor must be reinforced if Loads of 1,000 Lbs or more are anticipated.

	Old Part No.	New Part No.
Door Latch, Top for Cab. Models	HR-15	2-00018
Door Latch, Top, for Split Level Models	HR-9SL	2-00019
Dust Collector, BP, Top Drum		2-00115
Dust Collector, BP Residue Drum		2-00116
Filter Bag, (Weighted) for BP Dust Collector	FB-W	2-00030
Filter Bag, for Enclosed Dust Collector (Tubular) 52"		2-00031
Filter Bag, for Pull Thru Dust Collector, Tubular, 44"		2-00117
Filter Cone	FC-0	2-00118
Filter/Secondary Small, BP Dust Collector		2-00119
Filter, Fiber Glass Roll		2-00120
Foot Pedal Valve Only (for safety enclosed foot pedal)		2-00121
Foot Pedal and Valve Assembly (Hose Opt.) New Style		2-00041
Gasketing, 1/2" x 1/2"		2-00043
Gasketing, 1" x 3/8"		2-00111
Gasketing, 1" x 1/2"		2-00044
Gasketing, 1" x 1 1/2"		2-00045
Gasketing, 1 1/2" x 1/2"		2-00131
Gloves, Heavyweight, Rubber, 24"	GLH-45	2-00047
Gloves, Heavyweight, Neoprene, 24"	NG-12	2-00048
Gloves, Anti-Static, Rubber, 24"	GLH-45-C	2-00049
Gloves, Anti-static, Rubber, 30"		2-00193
Gloves, Heavyweight, Neoprene, 30"	GP-30	2-00046
Gloves, Heavyweight, Rubber, 8"		2-11147
Gloves, 8" Dia. Blue Gauntlet		2-02025
Impeller, BP Motor		2-00124
Lamp, Flourscent (U-Shaped)	USL	2-00080
Lamp, Shields, 6 x 12	LS-S	2-00081
Lamp, Shields, 12 x 25	LS-L	2-00082
Motor and Turbine Assembly for BP Dust Collector	BP-ASM-2	2-00083
Pressure Regulator, Gauge and Mounting Bracket (Hose Opt)	PRG-65	2-00086
Safety Valve Air	8187	2-00087
Side Door Handle		2-00127
Side Door Latch		2-00128
Siphon Hose, 5/8" I.D. for Master Models	PVH	2-00089
Siphon Hose, 5/8" I.D. Super Strong		2-00095
Siphon Tube Assembly	ST-78	2-00090
Spring, Counterbalance	RE-140	2-00091
Underlayment (to protect 12" x 24" Window — 10 Ft. Roll	WU24 x 120	2-00092
Underlayment Pre Cut 12" x 24" (10 pc. per pack)		2-00192
Underlayment, Pre Cut 12" x 19 1/2" (10 pc. per pack)		2-00292
Vacuum Hose, 2 1/2" I.D. for BP	VH-25	2-00093
Vacuum Hose, 4" I.D., for BP	VH-40	2-00094
Vibrator, Air (with Hose & Shut-off Valve)	TV130	2-00098
Vibrator, Elec. (with Mounting Bracket)	TVE-110	2-00099
Water Filter for Air Line, Manual Drain	WF-8	2-00100
Water Filter for Air Line, Auto Drain	WFA-8	2-00101
Water Filter for Air Line, Filter/Dryer	TF-1	2-00102
Water Filter for Air Line, Filter/Dryer (for Pressure Cabinet)	TF-2	2-00103
Water Filter for Air Line, Replace. Element C3846	TF-1-RE	2-00104
Water Filter for Air Line, Replace. Element C4186	TF-2RE	2-00105
Windows, 6" x 12" Acetate (6 per pack)	W-040-12	2-00106
Windows, 12" x 19 1/2", Acetate (3 per pack)	W-040-19	2-00107
Windows, 12" x 19 1/2" Safety Laminated Glass*		4-00105
Windows, 12" x 24" Plexiglass	WP12 x 24	2-00108
Windows, 12" x 24" Lexan	LW12 x 24	2-00109
Windows, 12" x 24", Safety Laminated Glass*	SGL-24	2-00110
Windows, Bandsaw, 4 per pack		2-00129

* Carton for glass window to ship in

4-00109

Old Part No.	New Part No.
-------------------------	-------------------------

CARBON SCREENS (FINE MESH FLOORING)

Carbon Screen, Model 20	2-00009
Carbon Screen, Model 24	2-00010
Carbon Screen, Model 30	2-00011
Carbon Screen, Model 36	2-00012
Carbon Screen, Model 36 x 30	2-00028
Carbon Screen, Model 48	2-00013
Carbon Screen, Model 42 x 24	2-00014
Carbon Screen, Model 48 x 24	2-00015
Carbon Screen, Model 48 x 36	2-00036
Carbon Screen, Model 40 x 40	2-00016
Carbon Screen, Model 48 x 48	2-00017
Carbon Screen, Model 60 x 48	2-00136

EXPANDEX FLOORS (WIDE MESH FLOORING)

Expandex Floor, Model 24	2-00020
Expandex Floor, Model 30	2-00021
Expandex Floor, Model 36	2-00022
Expandex Floor, Model 36 x 30	2-00029
Expandex Floor, Model 48	2-00023
Expandex Floor, Model 42 x 24	2-00024
Expandex Floor, Model 48 x 24	2-00025
Expandex Floor, Model 48 x 36	2-00037
Expandex Floor, Model 40 x 40*	2-00026
Expandex Floor, Model 48 x 48*	2-00027
Expandex Floor, Model 60 x 48*	2-00137

ABRASIVE SEPARATOR PARTS

Abrasive Separator Body Only, 300 CFM		6-00001
Abrasive Separator Body Only, 450 CFM		6-00002
Abrasive Separator Body Only, 600 CFM		6-00003
Door Latch (fits all Separators)	HR-15	6-00004
Exhaust Hose, 5" Dia. 300 CFM for Deluxe Models	EH-300	6-00005
Exhaust Hose, 6" Dia. 450/600 CFM for Deluxe Models	EH-600	6-00006
Filter Bag, 300 CFM	FB-300	6-00007
Filter Bag, 450/600 CFM	FB-600	6-00008
Filter Screen, inside reclaimer, 300 CFM	FS-300	6-00010
Filter Screen, inside reclaimer, 450/600 CFM	FS-600	6-00011
Impeller Fans, 300 CFM		6-00012
Impeller Fans, 450/600		6-00013
Impeller Fan Housing 300		6-00016
Impeller Fan Housing 450/600		6-00017
Media Pick-up Hose, 300/450, 4" Dia.	MH-300	6-00018
Media Pick-up Hose, 600, 5" Dia		6-00019
Metering Valve		6-00020
Motor, 300, 1/2 HP	300 MTR	6-00021
Motor, 450, 3/4 HP	450 MTR	6-00022
Motor, 600, 1 HP	600 MTR	6-00023
Side Door of Abras, Separator		6-00024

* Note: We are unable to ship these items via UPS. They are available for pick-up or shipment via common carrier only.

Minimum Order — \$20.00 Net

Other Parts Prices on Request — See Back Cover for Parts Diagram
Prices Subject to change Without Notice.

TRINCO™

TRINITY TOOL COMPANY

34600 Commerce Road • Fraser, MI 48026 • (586) 296-5900 • Fax (586) 296-5836

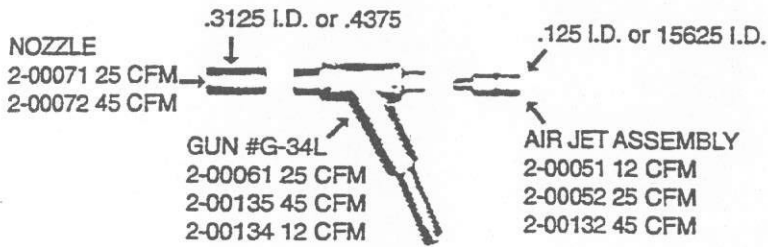
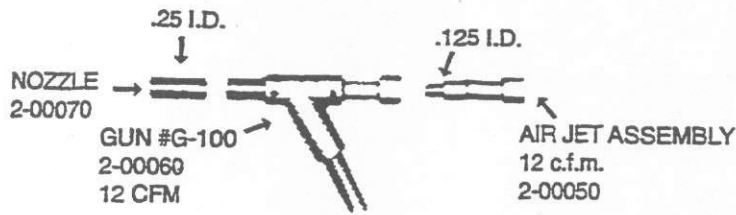

Important:

All valves or regulators have a marking "Air In & Out" or they have an arrow indicating direction of air flow. They will not work if this direction is reversed.

Trinco™ Pressure regulators assure a constant air flow.

Dry air is necessary for a steady flow of Abrasive. Trinco™ Water Filters remove excessive moisture from incoming air!

Note: 1/2" I.D. minimum air supply line is recommended!

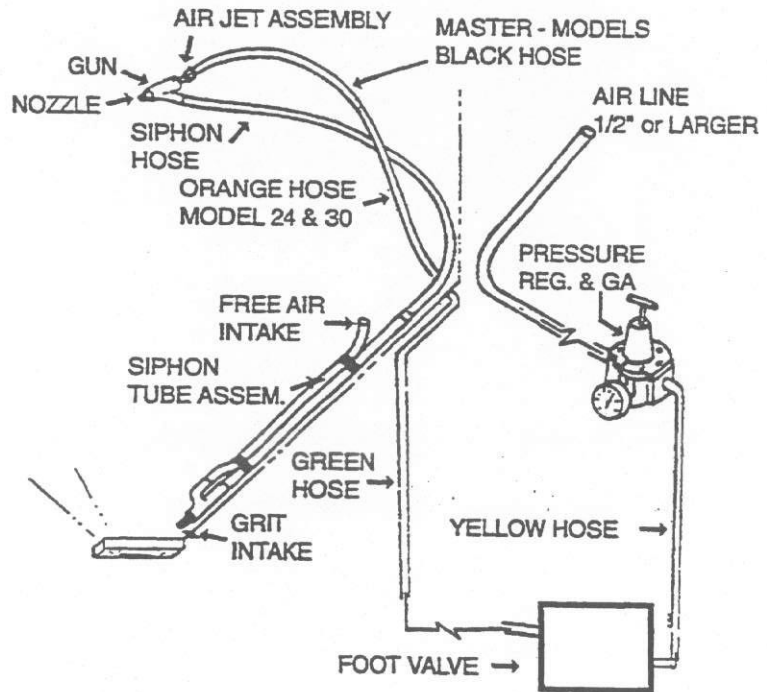

ABRASIVES
(QUANTITY DISCOUNTS)

ALUMINUM OXIDE
GLASS BEAD
TRIN-MIXES

SILICON CARBIDE
WALNUT SHELLS
CORN COB

PLASTIC MEDIA
GARNET
CUSTOM MIXES

FULL WAREHOUSE OF SPECIAL MEDIA AND GRIT SIZES.

TRINCO™
TRINITY TOOL COMPANY
1-(586) 296-5900

Fax: (586) 296-5836



Telephone (586) 296-5900

Fax (586) 296-5836

TRINITY TOOL COMPANY • 34600 COMMERCE ROAD • PO BOX 98

FRASER, MICHIGAN 48026-0098

Manufacturers of Trinco Dry-Blast Equipment and Trinco Abrasive - Since 1951

website: www.trinco.com

email: sales@trinco.com

LIMITED WARRANTY

Trinity Tool Company, the Company, warrants that all cabinets when properly installed as recommended, are free from defects in material and workmanship under normal use and service. The responsibility of the Company under this warranty is limited to repair or replacement at the Company's factory, of any part or parts thereof, which shall, within one year after date of shipment to the original Purchaser, be returned with transportation charges prepaid and which, upon examination shall be found to be defective to the satisfaction of the Company.

This warranty shall not apply to parts which are subjected to normal wear, misuse, negligence or accident or to parts which have been repaired or tampered with outside of the Company's factory, when in the judgment of the Company, it appears that the reliability or stability of the part or parts has been affected. Ordinary maintenance, such as adjustment and cleaning of equipment or components is the responsibility of the Purchaser.

Components purchased by Trinity Tool Company for which Vendor's established warranty prevails, will be repaired or replaced if defective, only in accordance with Vendor's established warranty policy.

This warranty is expressly in lieu of all other warranties expressed or implied and any other obligations or liability on the part of the Company.

NEVER USE SILICA-BASED PRODUCTS
IN TRINCO™ BLAST SYSTEMS
Ref. NIOSH Alert #92-102

TRINITY TOOL COMPANY